

PRODUCT CODE 90291

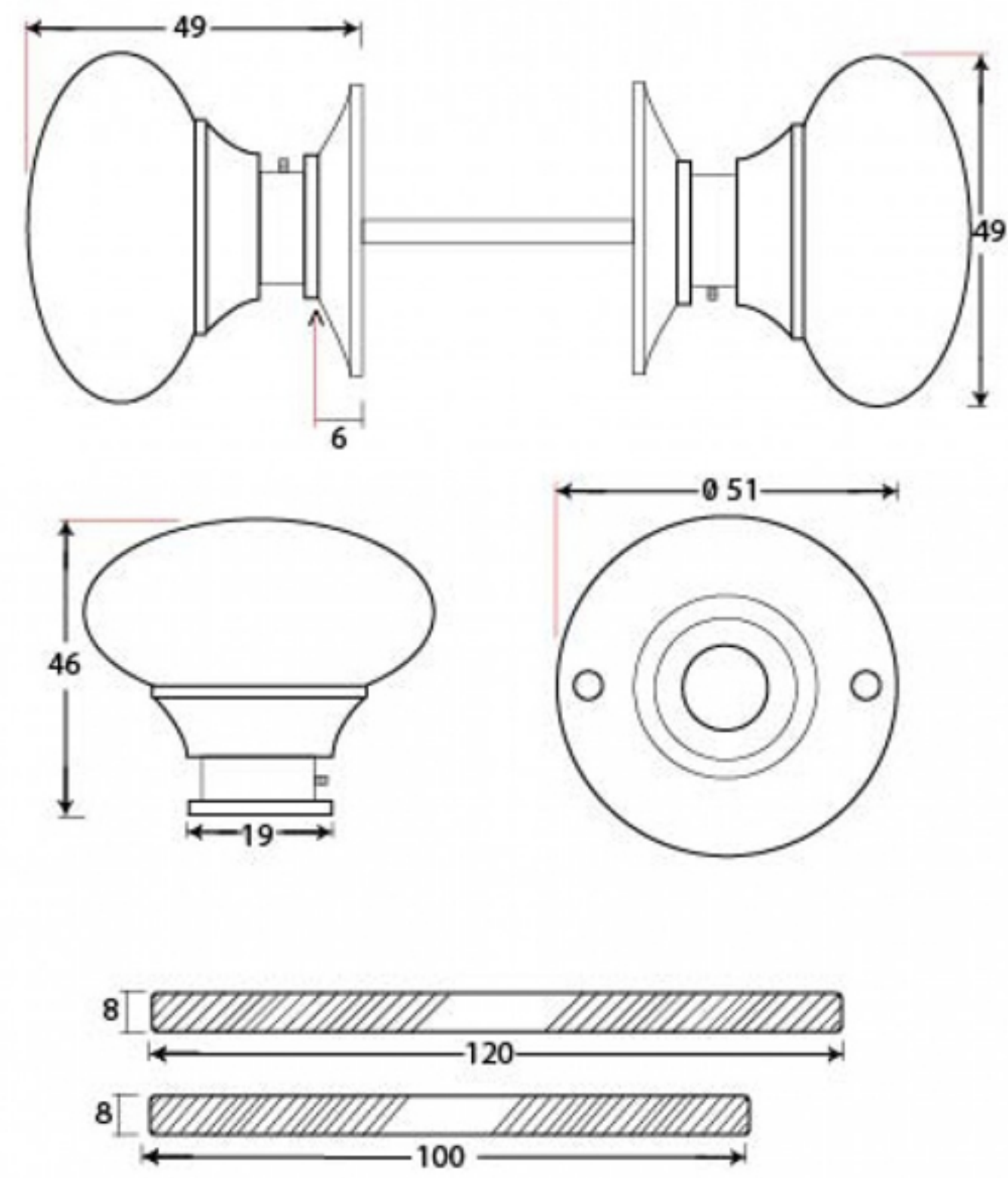

3/4" (19mm)
x4
gauge 4 (3mm)

HANDFORGED
TRADITIONAL
IRONMONGERY



Due to the hand crafted nature of our products all measurements are approximate and should be used as a guide only