

PRODUCT CODE 83912

3/4" (19mm)  
x4  
gauge 8 (4mm)

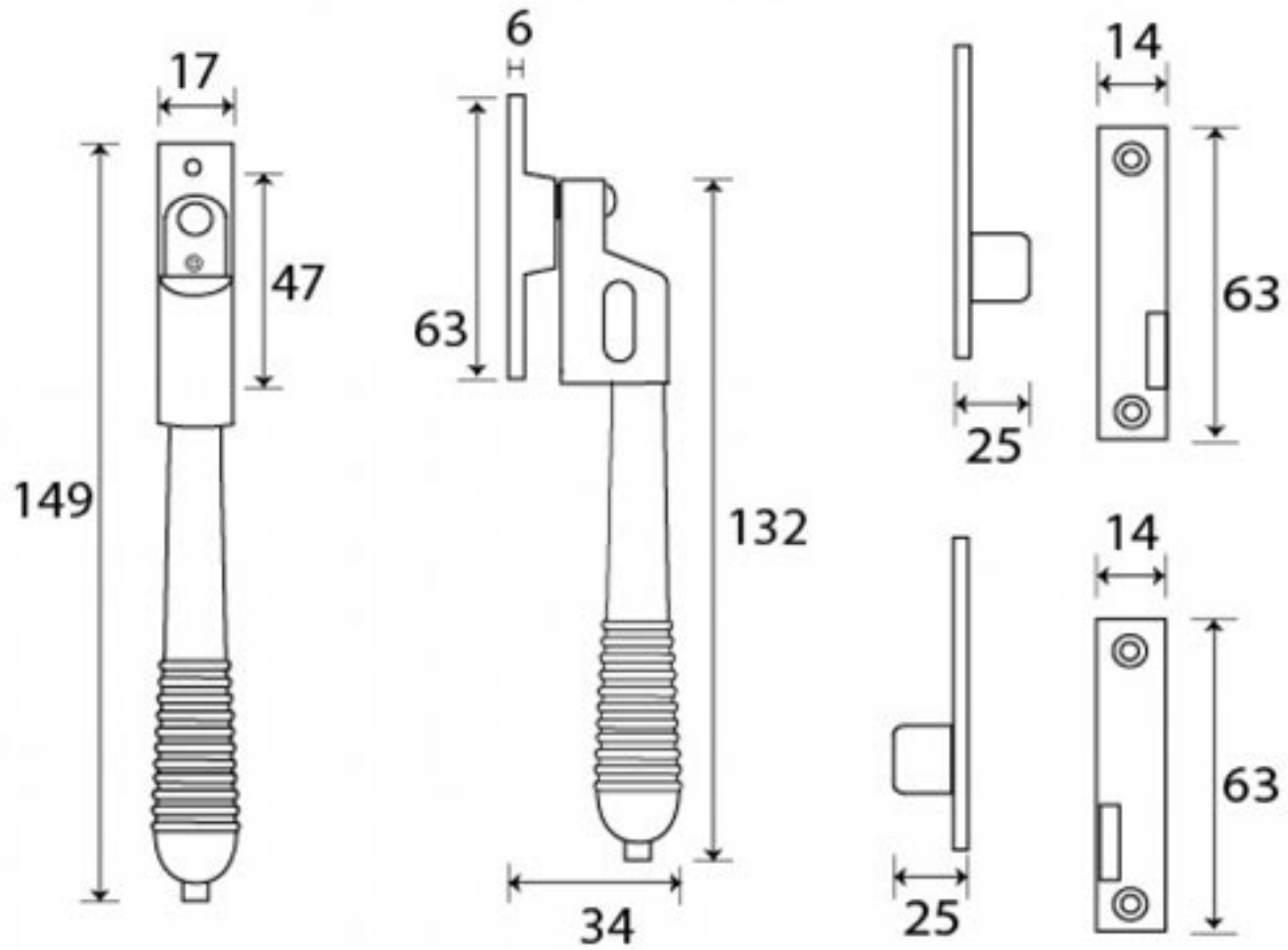

HANDFORGED  
TRADITIONAL  
IRONMONGERY



Due to the hand crafted nature of our products all measurements are approximate and should be used as a guide only