

PRODUCT CODE 91952

3/4" (19mm)
x4
gauge 8 (4mm)

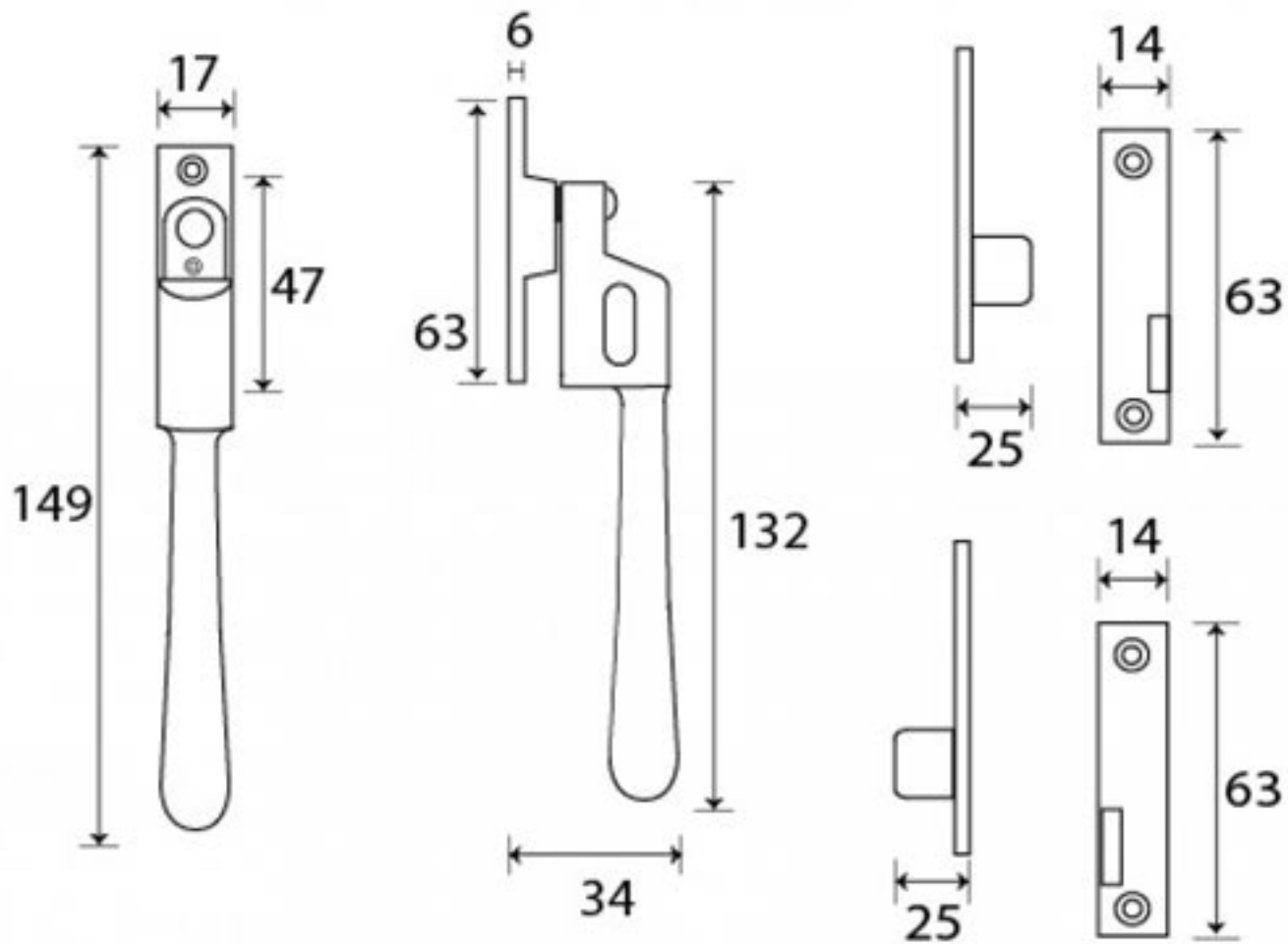

HANDFORGED
TRADITIONAL
IRONMONGERY



Due to the hand crafted nature of our products all measurements are approximate and should be used as a guide only