

PRODUCT CODE 90411

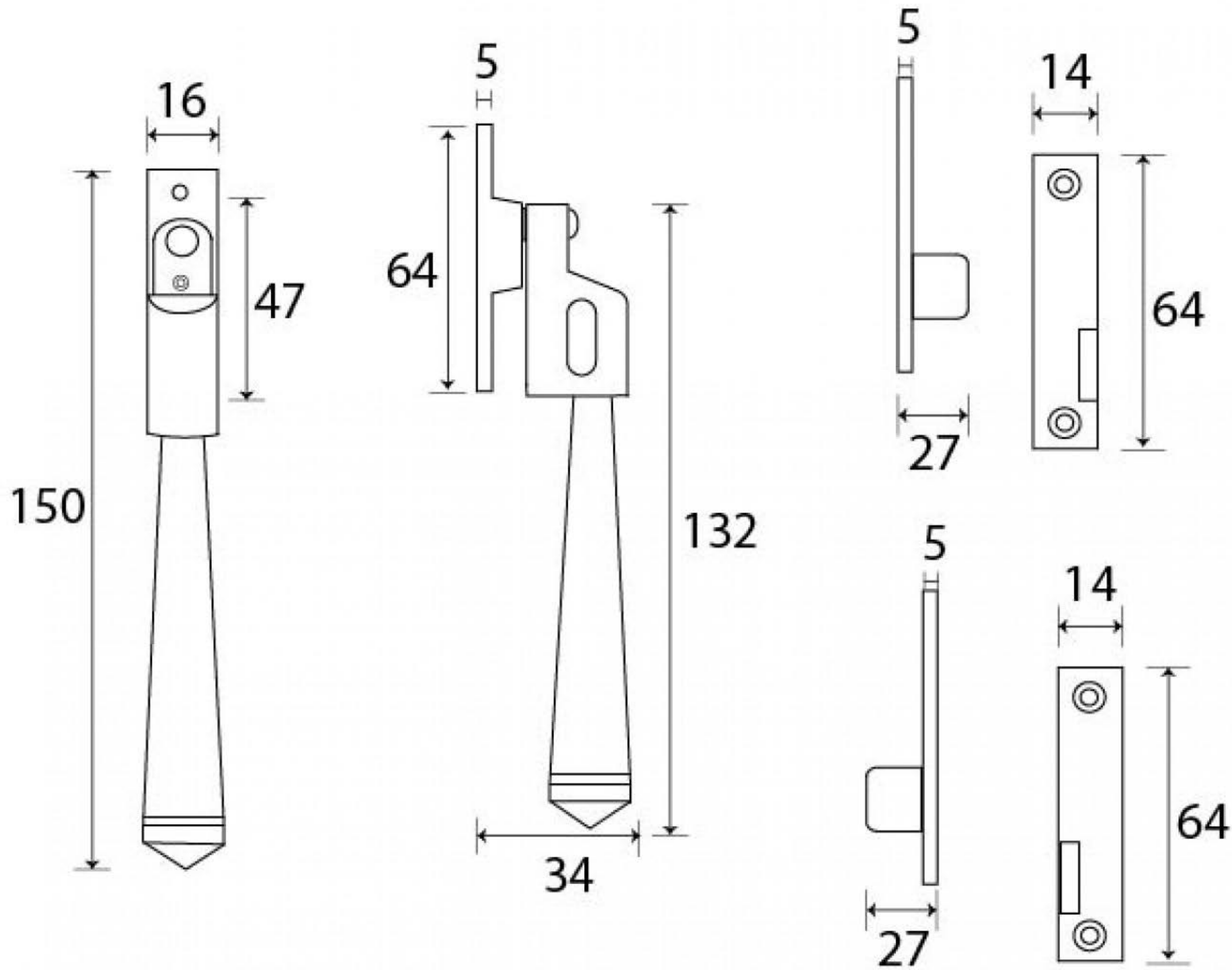

3/4" (19mm)
x 4
gauge 8 (4mm)

HANDFORGED
TRADITIONAL
IRONMONGERY



Due to the hand crafted nature of our products all measurements are approximate and should be used as a guide only