

PRODUCT CODE 91988

1/2" (12mm)  
x 2  
gauge 4 (3mm)

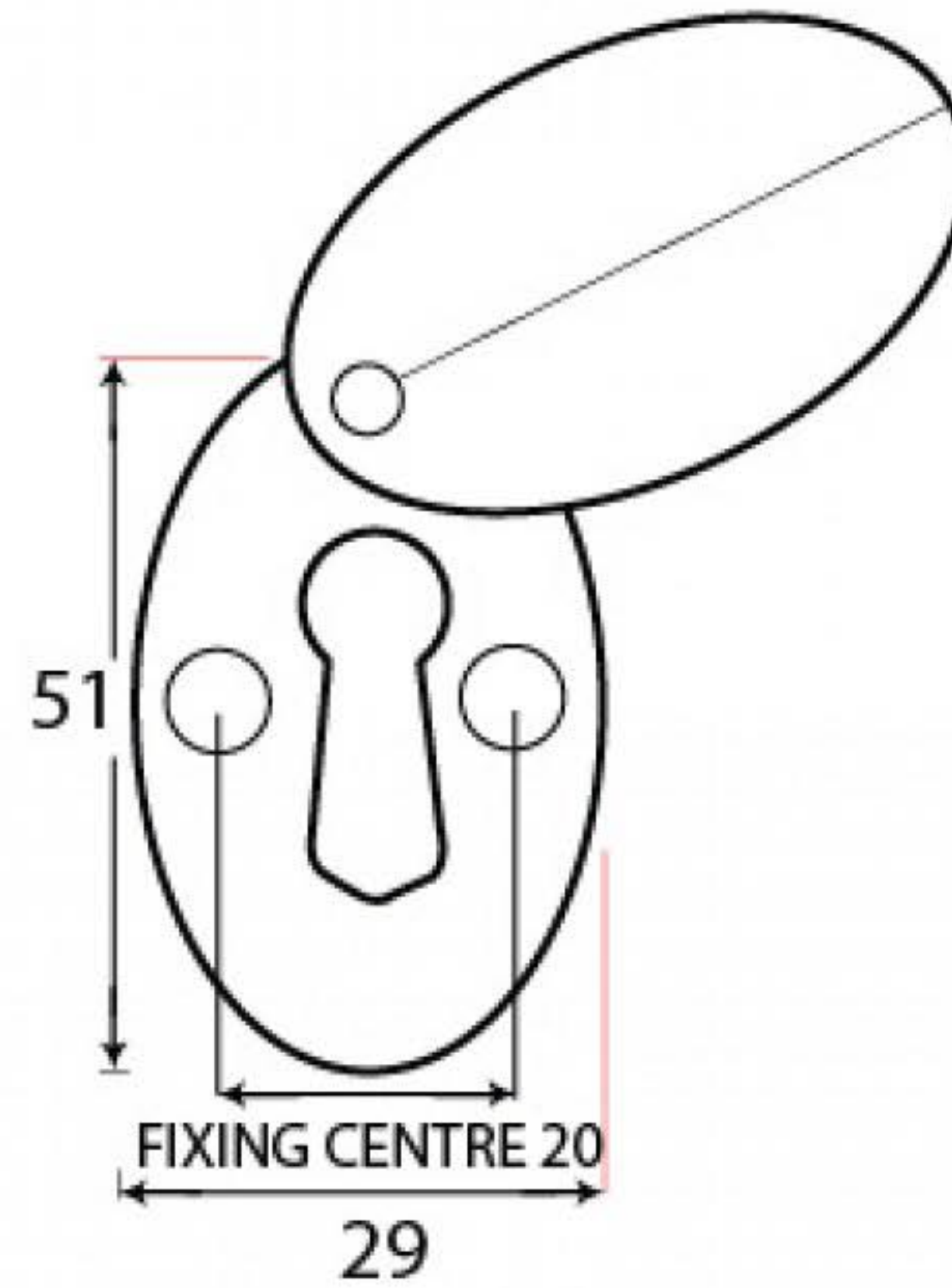

HANDFORGED  
TRADITIONAL  
IRONMONGERY



Due to the hand crafted nature of our products all measurements are approximate and should be used as a guide only